

IV88

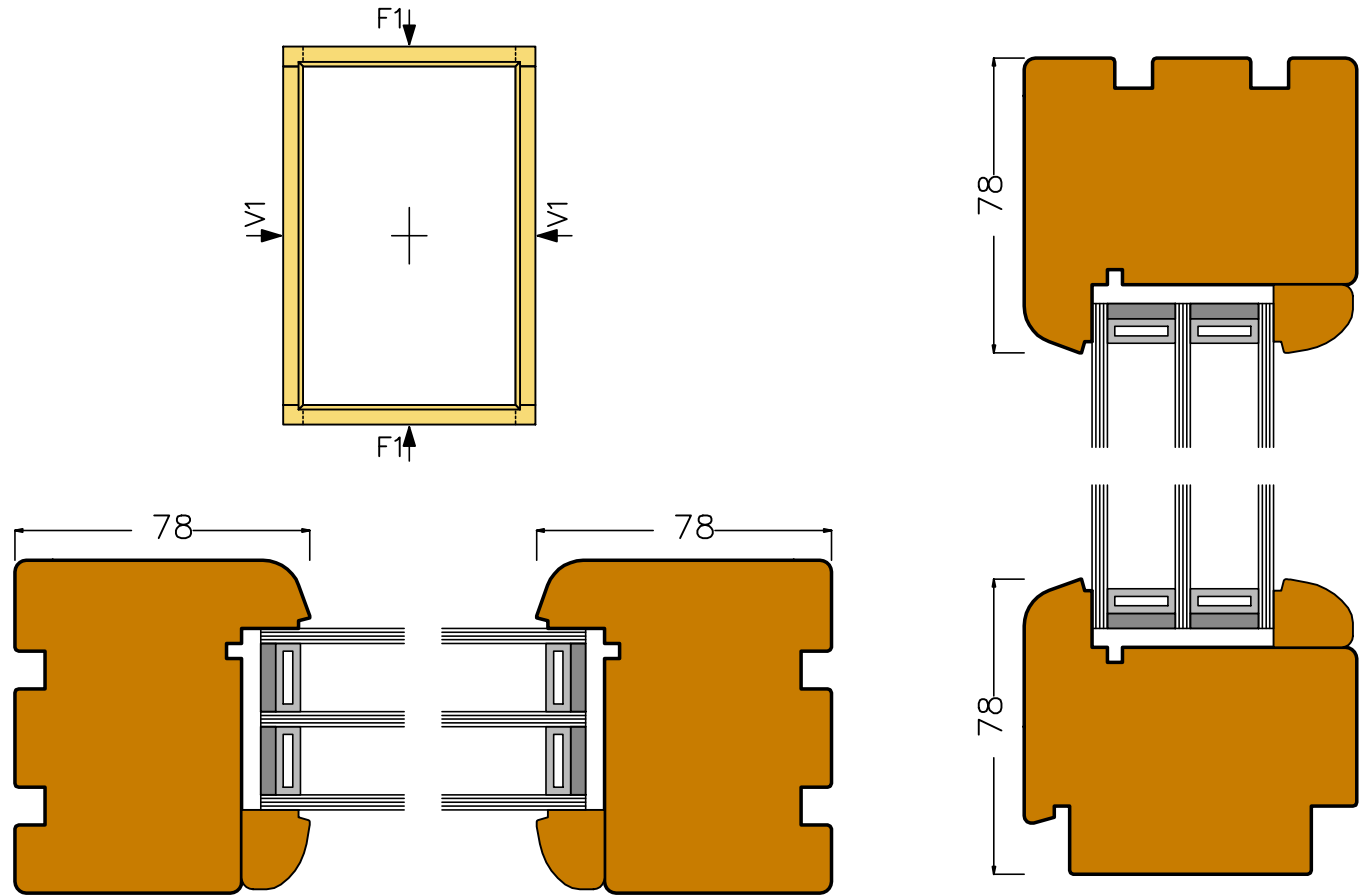

IV88

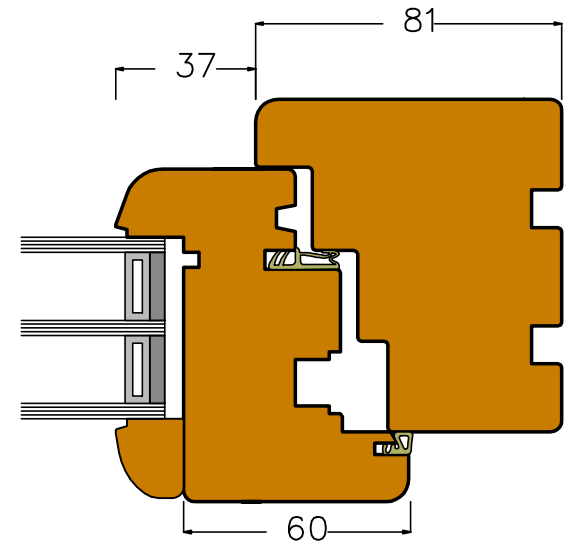
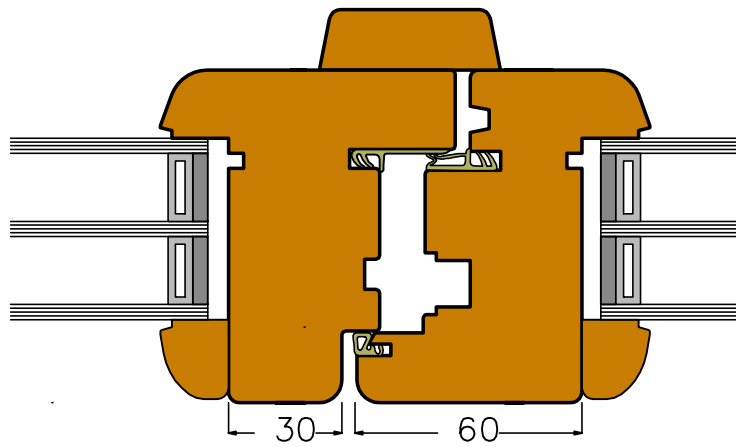
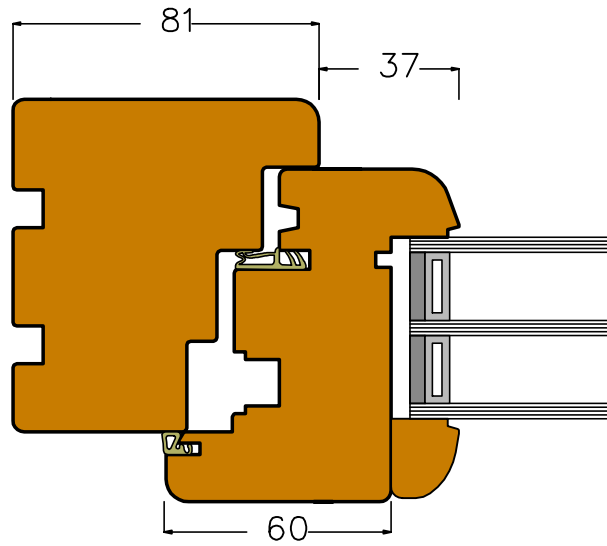
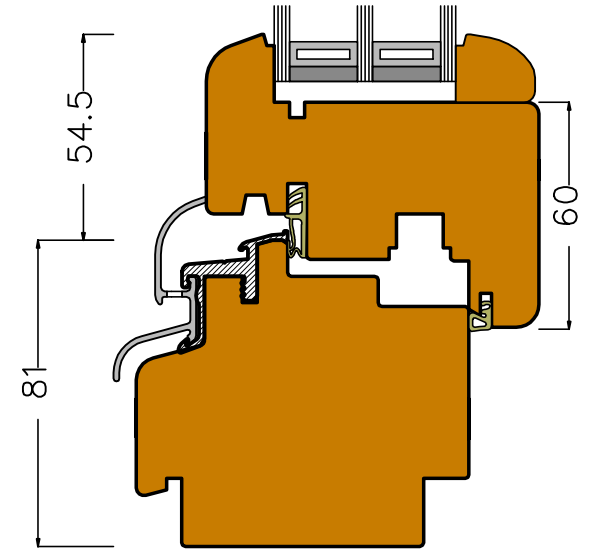
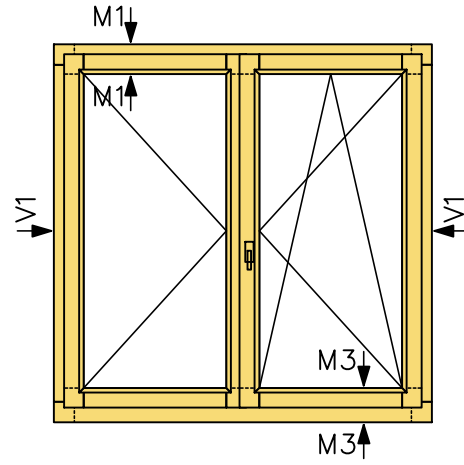
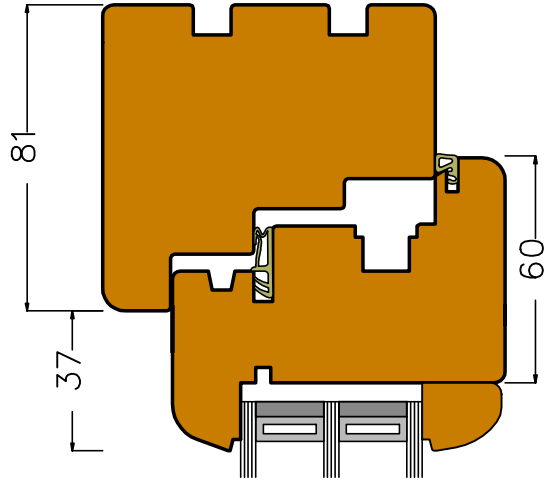

IV88

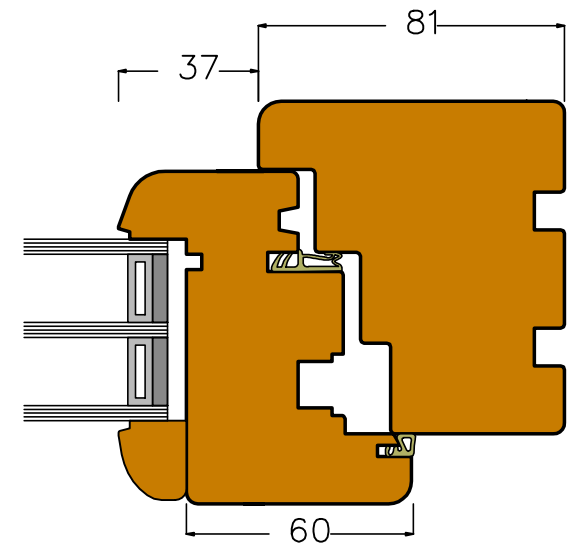
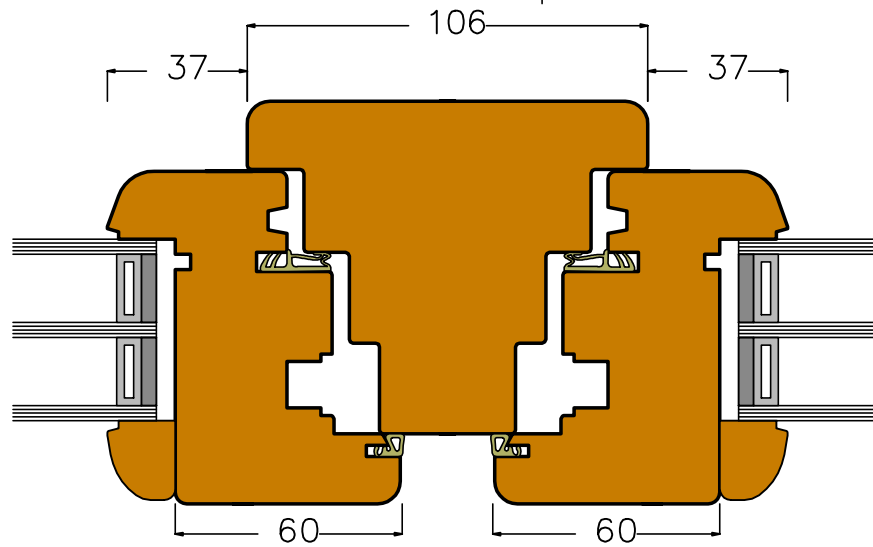
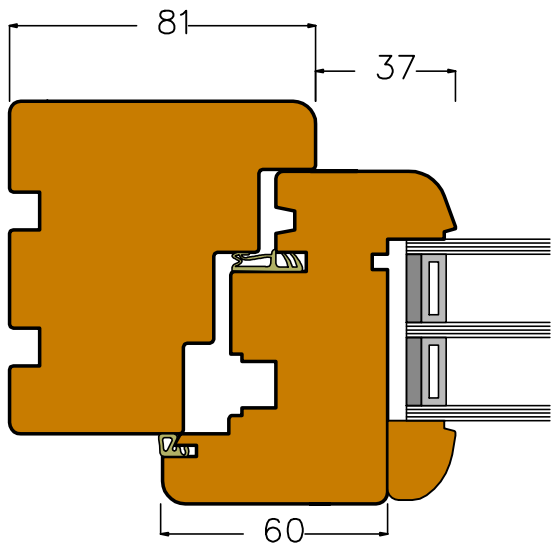
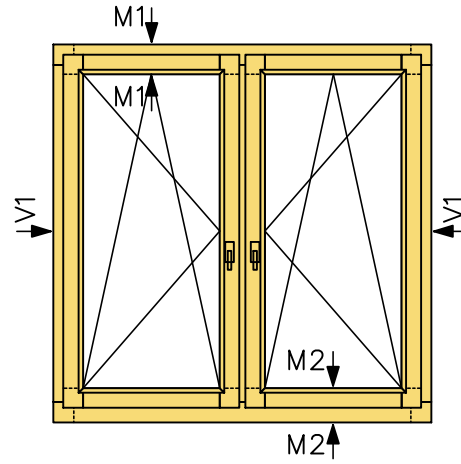
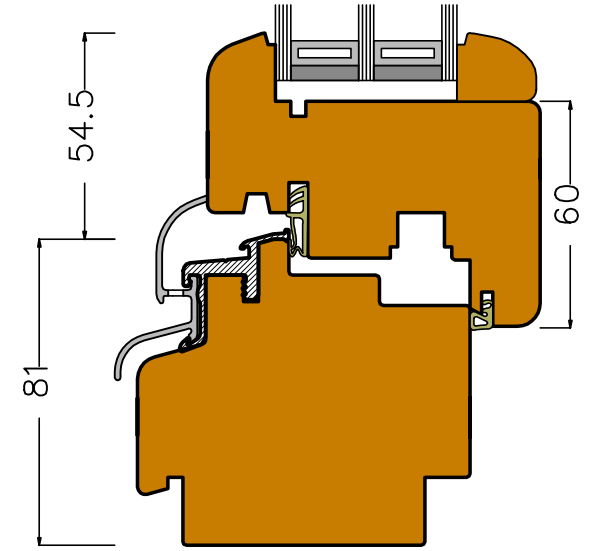
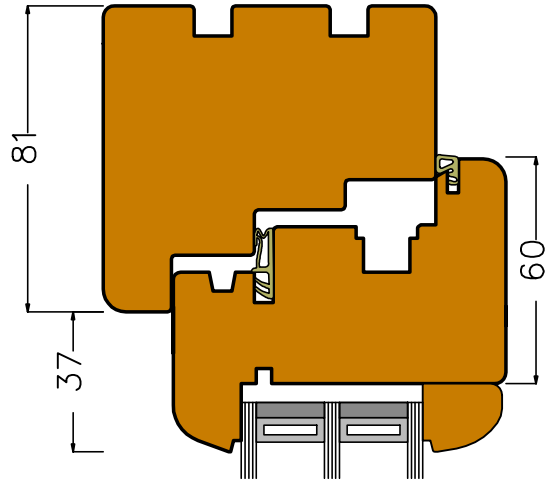

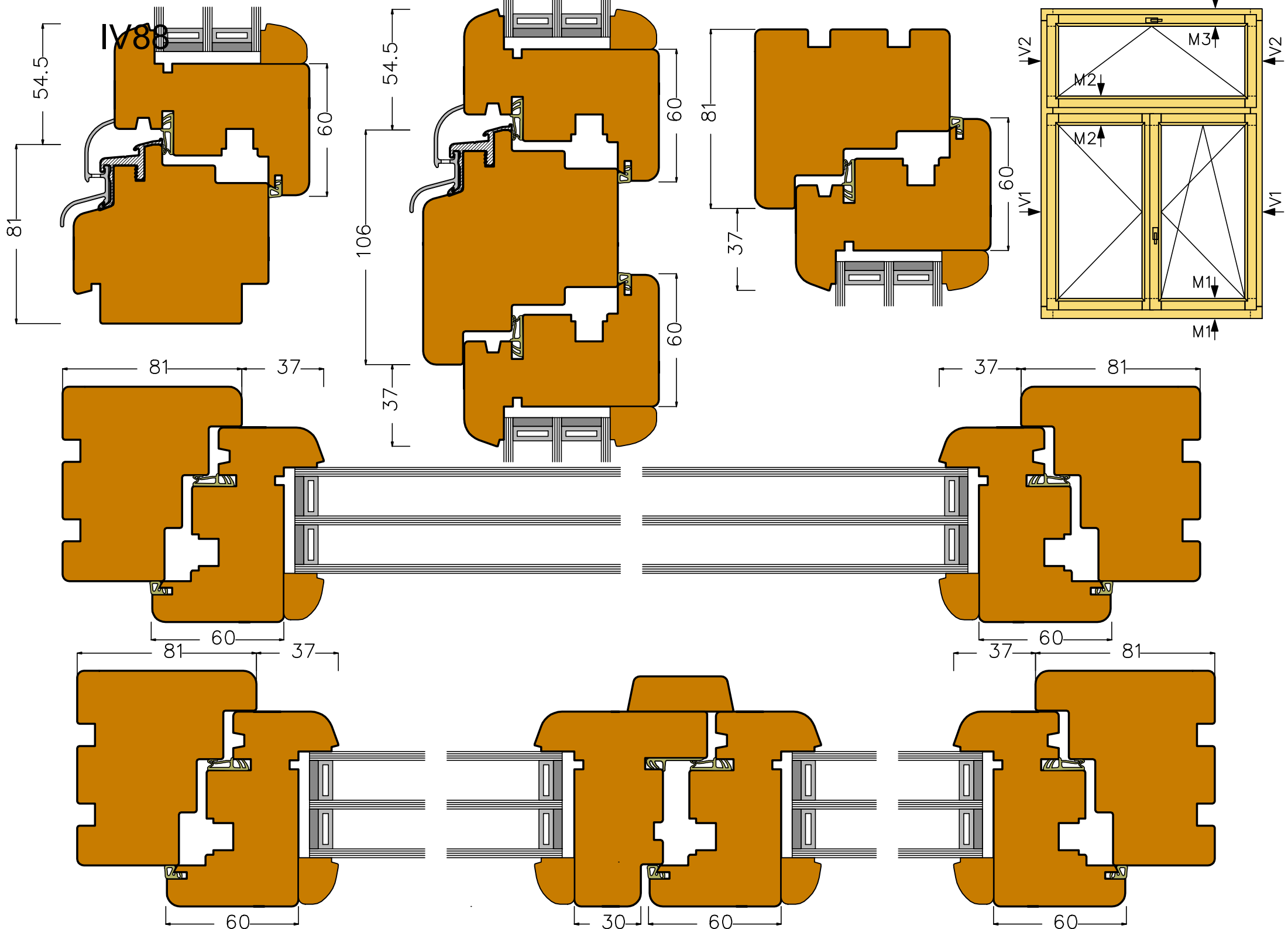

IV88

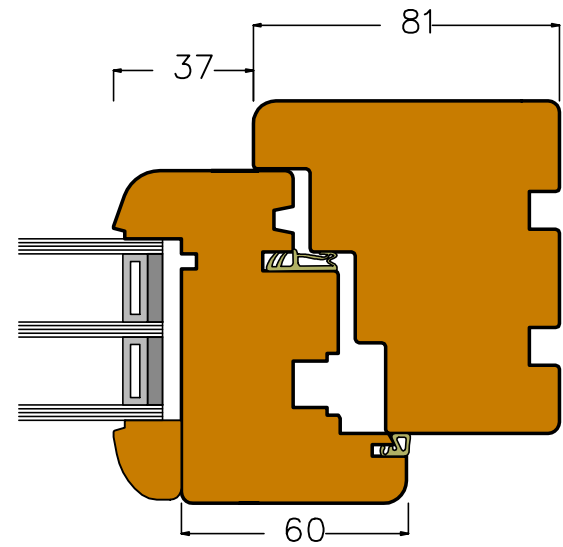
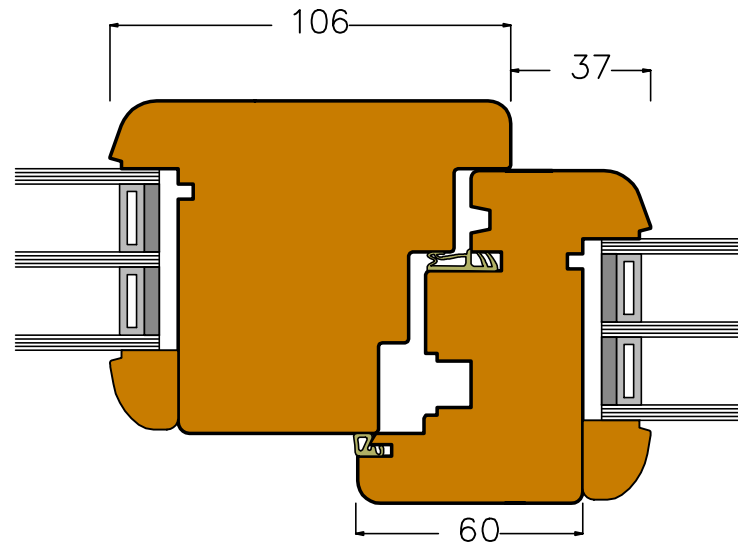
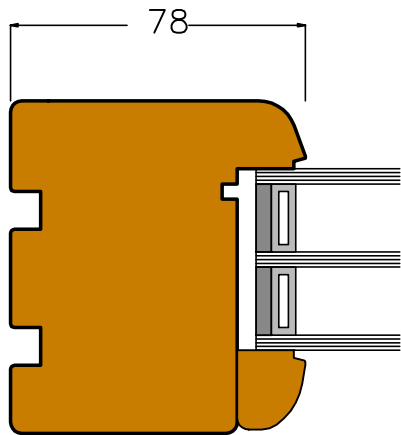
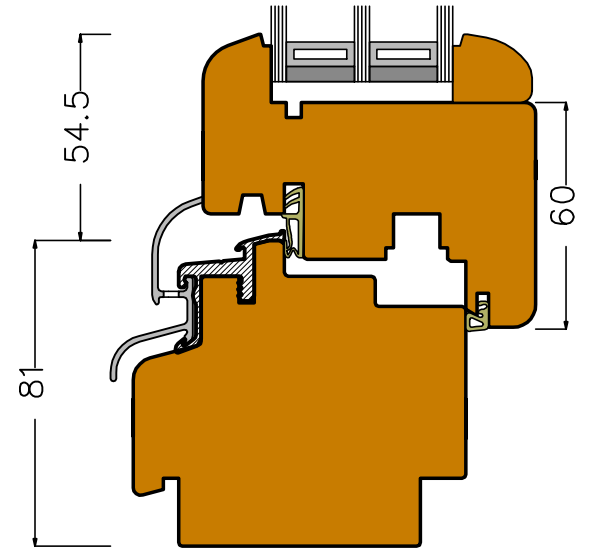
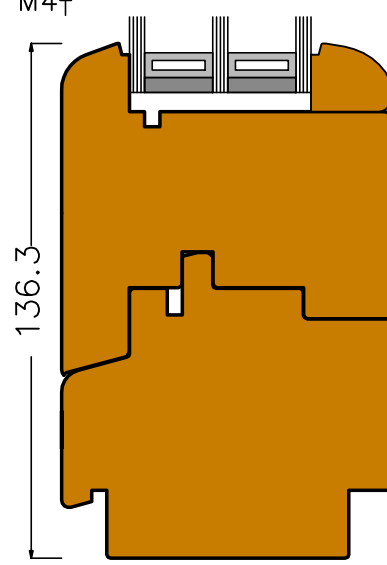
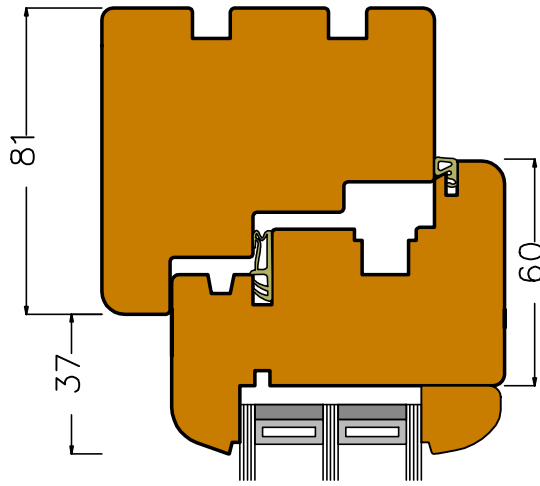
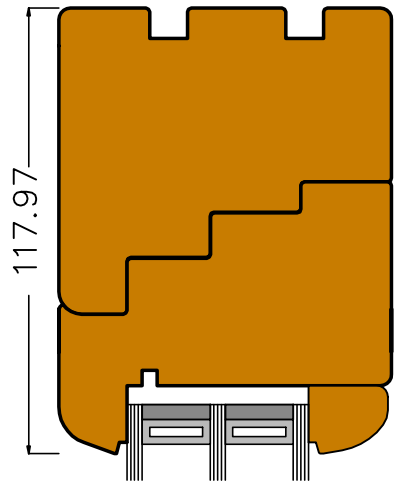
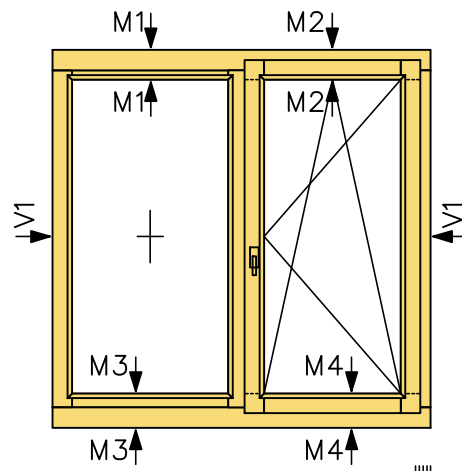

IV88

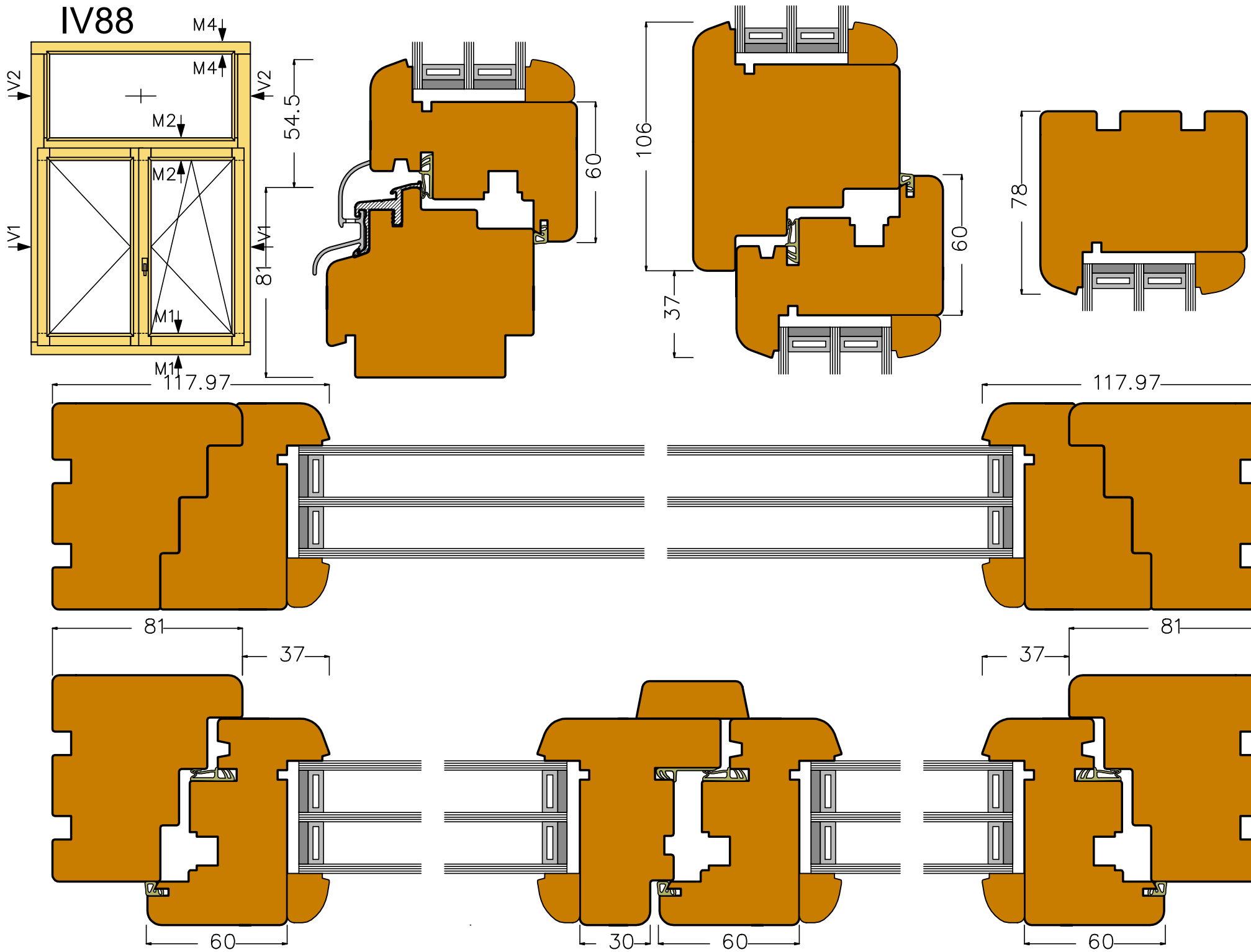

IV88

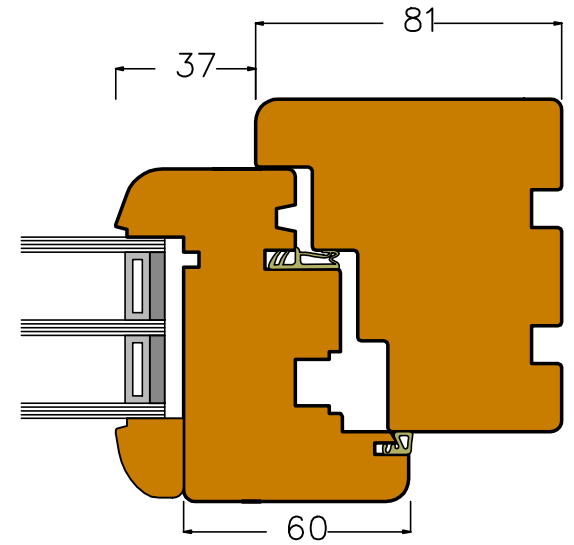
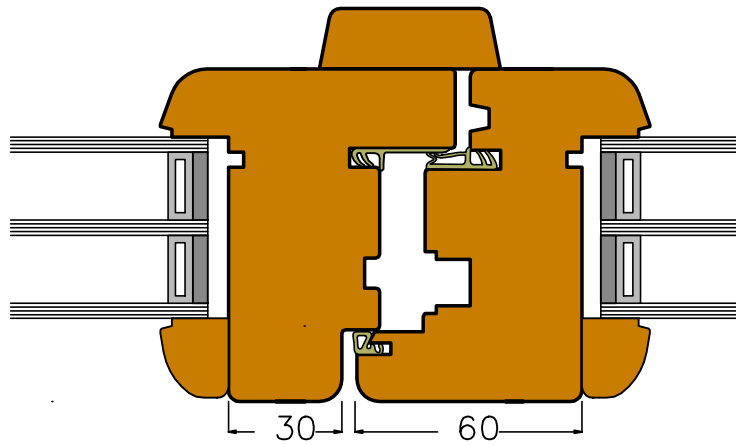
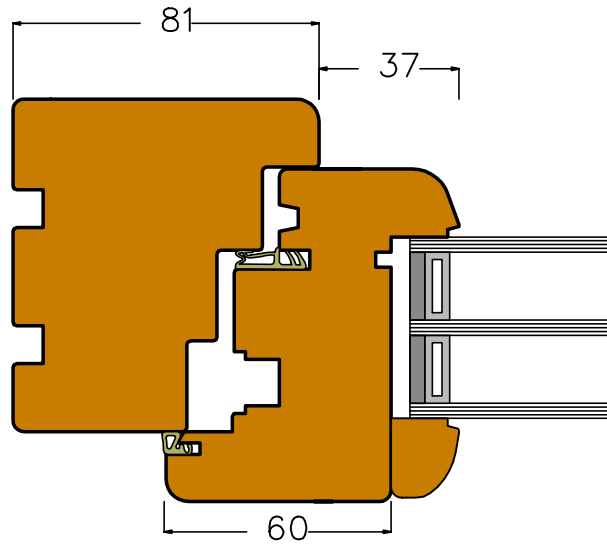
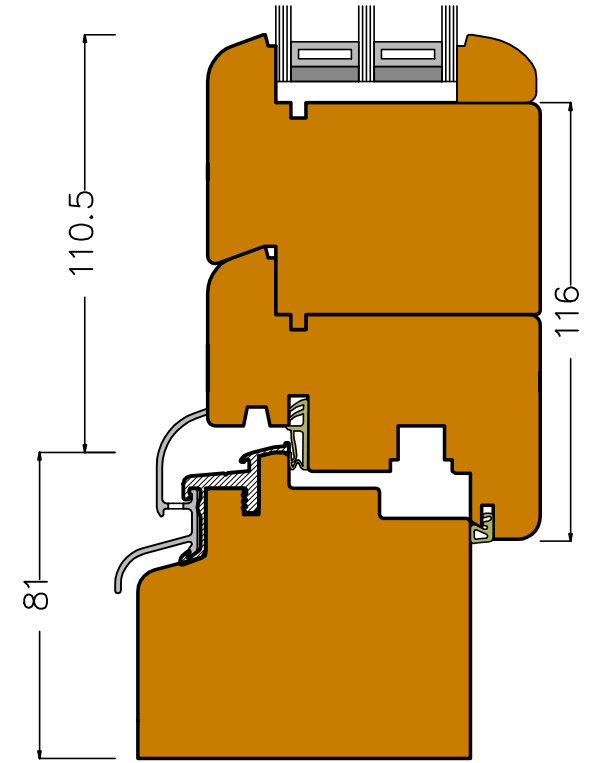
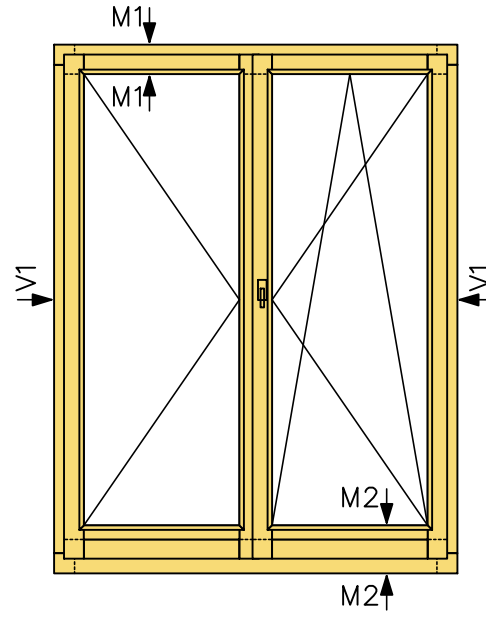
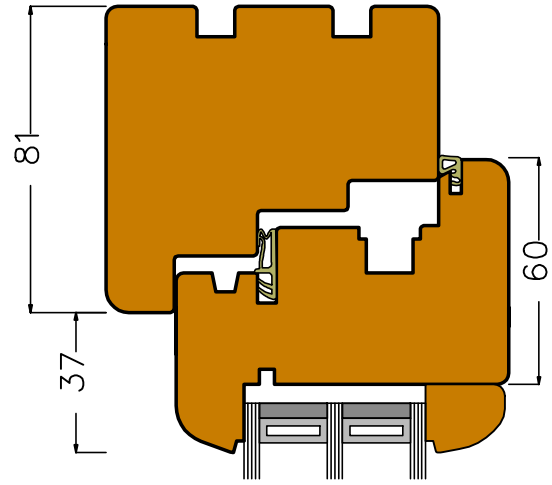

IV88

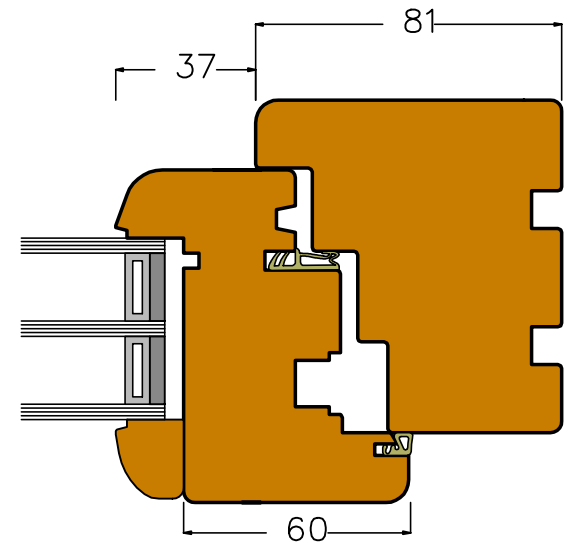
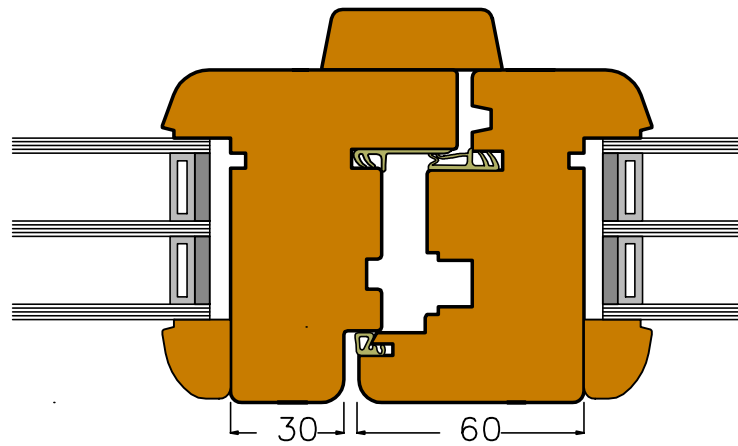
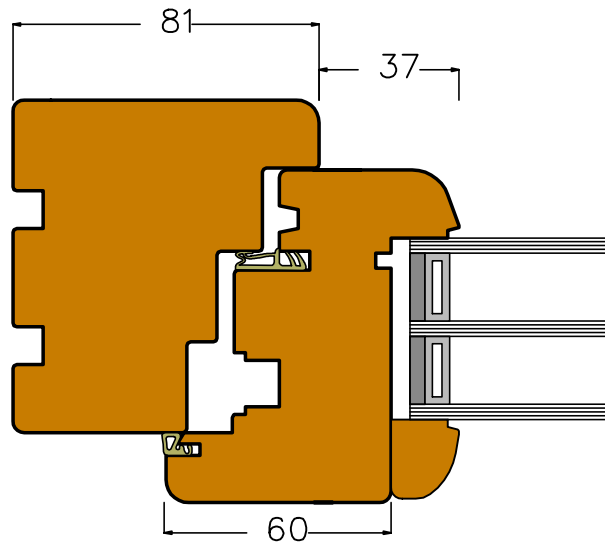
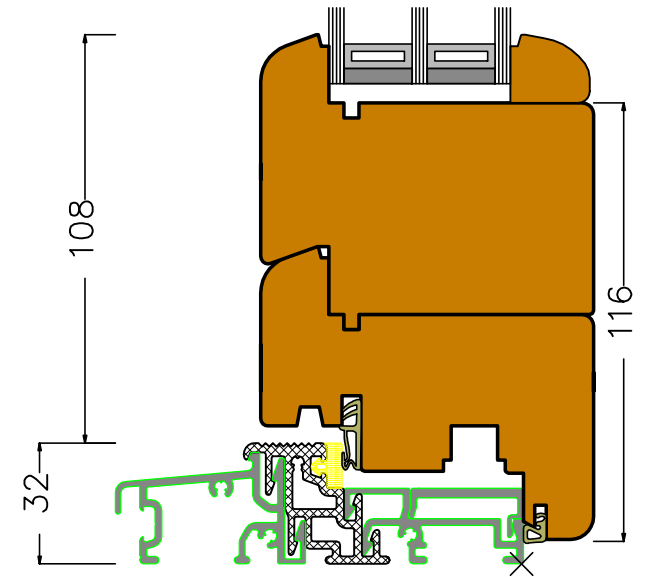
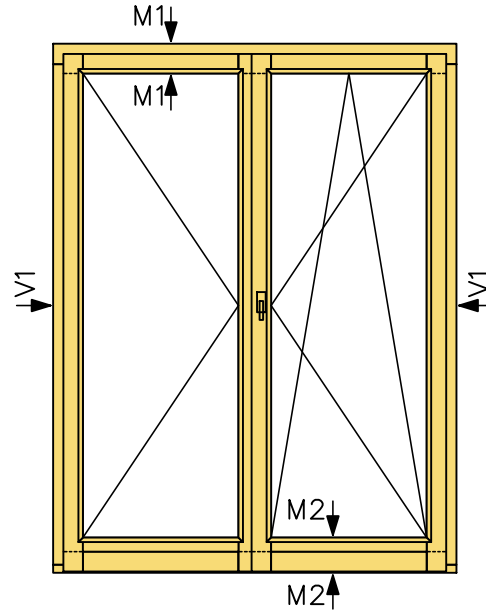
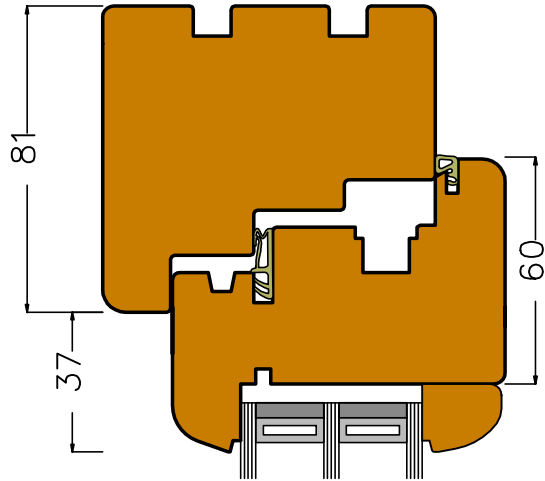

IV88

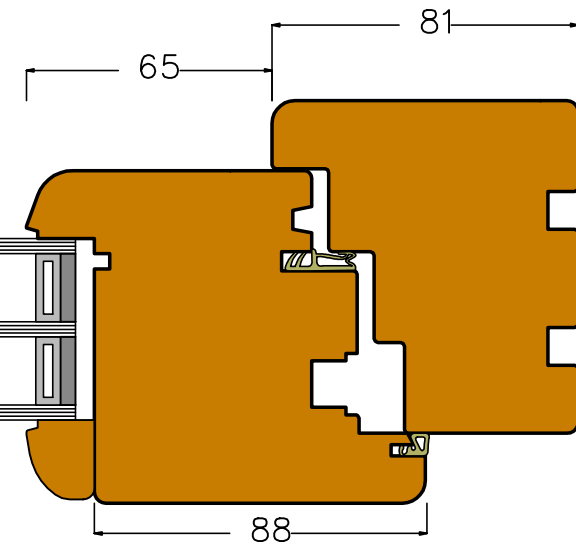
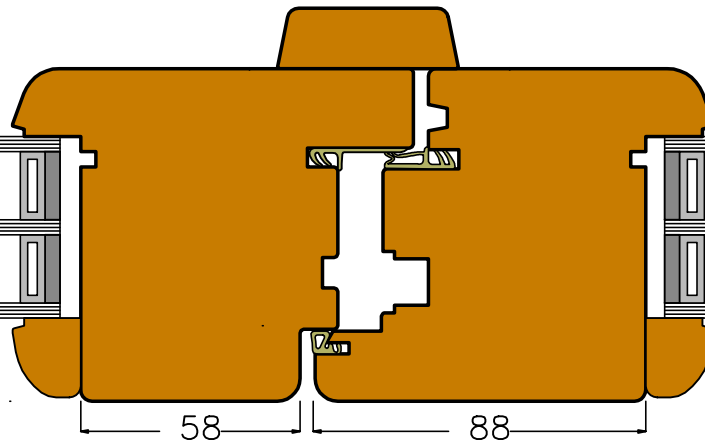
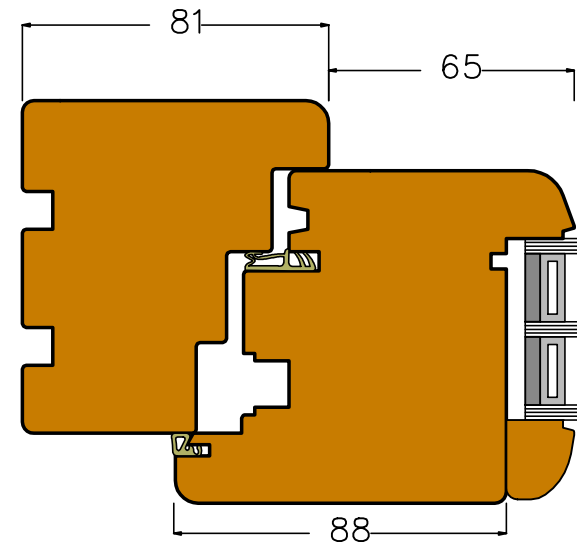
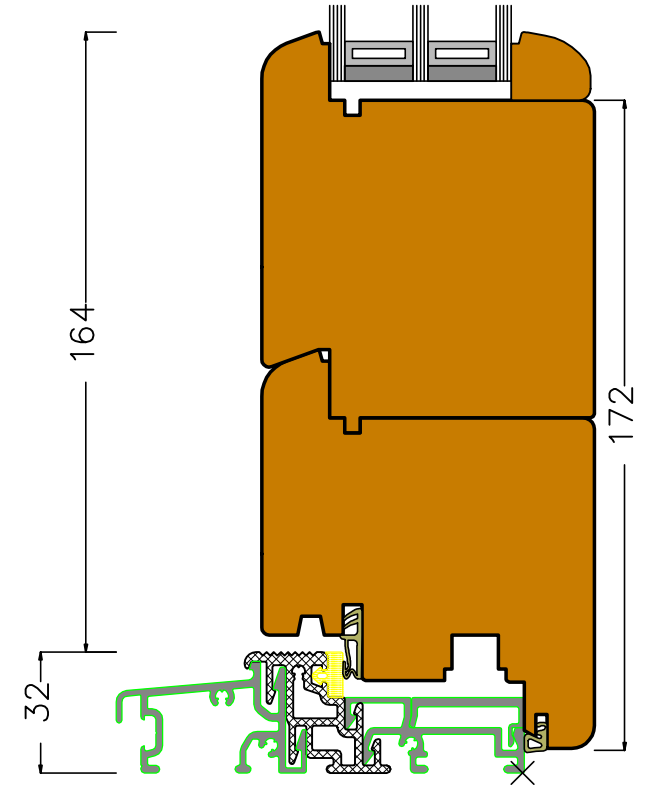
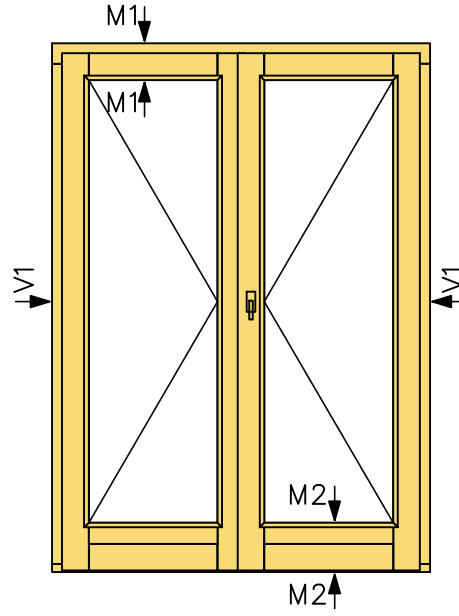
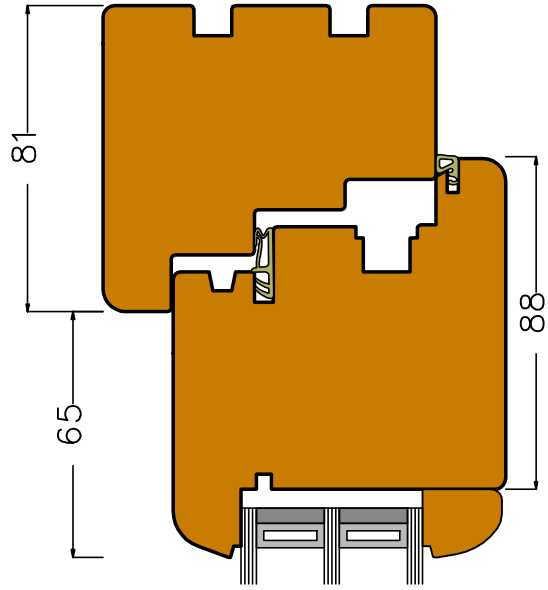

IV88

